

BUILDING SECTION
SCALE 1/4" = 1'-0"

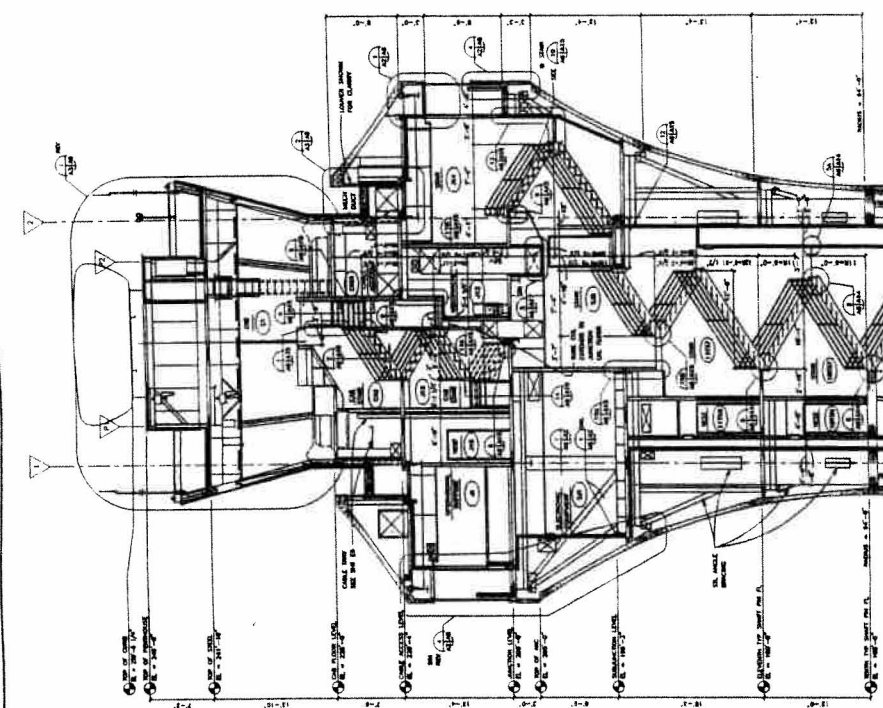

BUILDING SECTION
SCALE 1/4" = 1'-0"

DATE	DESCRIPTION
10/1/58	PRELIMINARY
10/15/58	REVISED
11/1/58	REVISED
11/15/58	REVISED
12/1/58	REVISED
12/15/58	REVISED
1/1/59	REVISED
1/15/59	REVISED
2/1/59	REVISED
2/15/59	REVISED
3/1/59	REVISED
3/15/59	REVISED
4/1/59	REVISED
4/15/59	REVISED
5/1/59	REVISED
5/15/59	REVISED
6/1/59	REVISED
6/15/59	REVISED
7/1/59	REVISED
7/15/59	REVISED
8/1/59	REVISED
8/15/59	REVISED
9/1/59	REVISED
9/15/59	REVISED
10/1/59	REVISED
10/15/59	REVISED
11/1/59	REVISED
11/15/59	REVISED
12/1/59	REVISED
12/15/59	REVISED
1/1/60	REVISED
1/15/60	REVISED
2/1/60	REVISED
2/15/60	REVISED
3/1/60	REVISED
3/15/60	REVISED
4/1/60	REVISED
4/15/60	REVISED
5/1/60	REVISED
5/15/60	REVISED
6/1/60	REVISED
6/15/60	REVISED
7/1/60	REVISED
7/15/60	REVISED
8/1/60	REVISED
8/15/60	REVISED
9/1/60	REVISED
9/15/60	REVISED
10/1/60	REVISED
10/15/60	REVISED
11/1/60	REVISED
11/15/60	REVISED
12/1/60	REVISED
12/15/60	REVISED
1/1/61	REVISED
1/15/61	REVISED
2/1/61	REVISED
2/15/61	REVISED
3/1/61	REVISED
3/15/61	REVISED
4/1/61	REVISED
4/15/61	REVISED
5/1/61	REVISED
5/15/61	REVISED
6/1/61	REVISED
6/15/61	REVISED
7/1/61	REVISED
7/15/61	REVISED
8/1/61	REVISED
8/15/61	REVISED
9/1/61	REVISED
9/15/61	REVISED
10/1/61	REVISED
10/15/61	REVISED
11/1/61	REVISED
11/15/61	REVISED
12/1/61	REVISED
12/15/61	REVISED
1/1/62	REVISED
1/15/62	REVISED
2/1/62	REVISED
2/15/62	REVISED
3/1/62	REVISED
3/15/62	REVISED
4/1/62	REVISED
4/15/62	REVISED
5/1/62	REVISED
5/15/62	REVISED
6/1/62	REVISED
6/15/62	REVISED
7/1/62	REVISED
7/15/62	REVISED
8/1/62	REVISED
8/15/62	REVISED
9/1/62	REVISED
9/15/62	REVISED
10/1/62	REVISED
10/15/62	REVISED
11/1/62	REVISED
11/15/62	REVISED
12/1/62	REVISED
12/15/62	REVISED
1/1/63	REVISED
1/15/63	REVISED
2/1/63	REVISED
2/15/63	REVISED
3/1/63	REVISED
3/15/63	REVISED
4/1/63	REVISED
4/15/63	REVISED
5/1/63	REVISED
5/15/63	REVISED
6/1/63	REVISED
6/15/63	REVISED
7/1/63	REVISED
7/15/63	REVISED
8/1/63	REVISED
8/15/63	REVISED
9/1/63	REVISED
9/15/63	REVISED
10/1/63	REVISED
10/15/63	REVISED
11/1/63	REVISED
11/15/63	REVISED
12/1/63	REVISED
12/15/63	REVISED
1/1/64	REVISED
1/15/64	REVISED
2/1/64	REVISED
2/15/64	REVISED
3/1/64	REVISED
3/15/64	REVISED
4/1/64	REVISED
4/15/64	REVISED
5/1/64	REVISED
5/15/64	REVISED
6/1/64	REVISED
6/15/64	REVISED
7/1/64	REVISED
7/15/64	REVISED
8/1/64	REVISED
8/15/64	REVISED
9/1/64	REVISED
9/15/64	REVISED
10/1/64	REVISED
10/15/64	REVISED
11/1/64	REVISED
11/15/64	REVISED
12/1/64	REVISED
12/15/64	REVISED
1/1/65	REVISED
1/15/65	REVISED
2/1/65	REVISED
2/15/65	REVISED
3/1/65	REVISED
3/15/65	REVISED
4/1/65	REVISED
4/15/65	REVISED
5/1/65	REVISED
5/15/65	REVISED
6/1/65	REVISED
6/15/65	REVISED
7/1/65	REVISED
7/15/65	REVISED
8/1/65	REVISED
8/15/65	REVISED
9/1/65	REVISED
9/15/65	REVISED
10/1/65	REVISED
10/15/65	REVISED
11/1/65	REVISED
11/15/65	REVISED
12/1/65	REVISED
12/15/65	REVISED
1/1/66	REVISED
1/15/66	REVISED
2/1/66	REVISED
2/15/66	REVISED
3/1/66	REVISED
3/15/66	REVISED
4/1/66	REVISED
4/15/66	REVISED
5/1/66	REVISED
5/15/66	REVISED
6/1/66	REVISED
6/15/66	REVISED
7/1/66	REVISED
7/15/66	REVISED
8/1/66	REVISED
8/15/66	REVISED
9/1/66	REVISED
9/15/66	REVISED
10/1/66	REVISED
10/15/66	REVISED
11/1/66	REVISED
11/15/66	REVISED
12/1/66	REVISED
12/15/66	REVISED
1/1/67	REVISED
1/15/67	REVISED
2/1/67	REVISED
2/15/67	REVISED
3/1/67	REVISED
3/15/67	REVISED
4/1/67	REVISED
4/15/67	REVISED
5/1/67	REVISED
5/15/67	REVISED
6/1/67	REVISED
6/15/67	REVISED
7/1/67	REVISED
7/15/67	REVISED
8/1/67	REVISED
8/15/67	REVISED
9/1/67	REVISED
9/15/67	REVISED
10/1/67	REVISED
10/15/67	REVISED
11/1/67	REVISED
11/15/67	REVISED
12/1/67	REVISED
12/15/67	REVISED
1/1/68	REVISED
1/15/68	REVISED
2/1/68	REVISED
2/15/68	REVISED
3/1/68	REVISED
3/15/68	REVISED
4/1/68	REVISED
4/15/68	REVISED
5/1/68	REVISED
5/15/68	REVISED
6/1/68	REVISED
6/15/68	REVISED
7/1/68	REVISED
7/15/68	REVISED
8/1/68	REVISED
8/15/68	REVISED
9/1/68	REVISED
9/15/68	REVISED
10/1/68	REVISED
10/15/68	REVISED
11/1/68	REVISED
11/15/68	REVISED
12/1/68	REVISED
12/15/68	REVISED
1/1/69	REVISED
1/15/69	REVISED
2/1/69	REVISED
2/15/69	REVISED
3/1/69	REVISED
3/15/69	REVISED
4/1/69	REVISED
4/15/69	REVISED
5/1/69	REVISED
5/15/69	REVISED
6/1/69	REVISED
6/15/69	REVISED
7/1/69	REVISED
7/15/69	REVISED
8/1/69	REVISED
8/15/69	REVISED
9/1/69	REVISED
9/15/69	REVISED
10/1/69	REVISED
10/15/69	REVISED
11/1/69	REVISED
11/15/69	REVISED
12/1/69	REVISED
12/15/69	REVISED
1/1/70	REVISED
1/15/70	REVISED
2/1/70	REVISED
2/15/70	REVISED
3/1/70	REVISED
3/15/70	REVISED
4/1/70	REVISED
4/15/70	REVISED
5/1/70	REVISED
5/15/70	REVISED
6/1/70	REVISED
6/15/70	REVISED
7/1/70	REVISED
7/15/70	REVISED
8/1/70	REVISED
8/15/70	REVISED
9/1/70	REVISED
9/15/70	REVISED
10/1/70	REVISED
10/15/70	REVISED
11/1/70	REVISED
11/15/70	REVISED
12/1/70	REVISED
12/15/70	REVISED
1/1/71	REVISED
1/15/71	REVISED
2/1/71	REVISED
2/15/71	REVISED
3/1/71	REVISED
3/15/71	REVISED
4/1/71	REVISED
4/15/71	REVISED
5/1/71	REVISED
5/15/71	REVISED
6/1/71	REVISED
6/15/71	REVISED
7/1/71	REVISED
7/15/71	REVISED
8/1/71	REVISED
8/15/71	REVISED
9/1/71	REVISED
9/15/71	REVISED
10/1/71	REVISED
10/15/71	REVISED
11/1/71	REVISED
11/15/71	REVISED
12/1/71	REVISED
12/15/71	REVISED
1/1/72	REVISED
1/15/72	REVISED
2/1/72	REVISED
2/15/72	REVISED
3/1/72	REVISED
3/15/72	REVISED
4/1/72	REVISED
4/15/72	REVISED
5/1/72	REVISED
5/15/72	REVISED
6/1/72	REVISED
6/15/72	REVISED
7/1/72	REVISED
7/15/72	REVISED
8/1/72	REVISED
8/15/72	REVISED
9/1/72	REVISED
9/15/72	REVISED
10/1/72	REVISED
10/15/72	REVISED
11/1/72	REVISED
11/15/72	REVISED
12/1/72	REVISED
12/15/72	REVISED
1/1/73	REVISED
1/15/73	REVISED
2/1/73	REVISED
2/15/73	REVISED
3/1/73	REVISED
3/15/73	REVISED
4/1/73	REVISED
4/15/73	REVISED
5/1/73	REVISED
5/15/73	REVISED
6/1/73	REVISED
6/15/73	REVISED
7/1/73	REVISED
7/15/73	REVISED
8/1/73	REVISED
8/15/73	REVISED
9/1/73	REVISED
9/15/73	REVISED
10/1/73	REVISED
10/15/73	REVISED
11/1/73	REVISED
11/15/73	REVISED
12/1/73	REVISED
12/15/73	REVISED
1/1/74	REVISED
1/15/74	REVISED
2/1/74	REVISED
2/15/74	REVISED
3/1/74	REVISED
3/15/74	REVISED
4/1/74	REVISED
4/15/74	REVISED
5/1/74	REVISED
5/15/74	REVISED
6/1/74	REVISED
6/15/74	REVISED
7/1/74	REVISED
7/15/74	REVISED
8/1/74	REVISED
8/15/74	REVISED
9/1/74	REVISED
9/15/74	REVISED
10/1/74	REVISED
10/15/74	REVISED
11/1/74	REVISED
11/15/74	REVISED
12/1/74	REVISED
12/15/74	REVISED
1/1/75	REVISED
1/15/75	REVISED
2/1/75	REVISED
2/15/75	REVISED
3/1/75	REVISED
3/15/75	REVISED
4/1/75	REVISED
4/15/75	REVISED
5/1/75	REVISED
5/15/75	REVISED
6/1/75	REVISED
6/15/75	REVISED
7/1/75	REVISED
7/15/75	REVISED
8/1/75	REVISED
8/15/75	REVISED
9/1/75	REVISED
9/15/75	REVISED
10/1/75	REVISED
10/15/75	REVISED
11/1/75	REVISED
11/15/75	REVISED
12/1/75	REVISED
12/15/75	REVISED
1/1/76	REVISED
1/15/76	REVISED
2/1/76	REVISED
2/15/76	REVISED
3/1/76	REVISED
3/15/76	REVISED
4/1/76	REVISED
4/15/76	REVISED
5/1/76	REVISED
5/15/76	REVISED
6/1/76	REVISED
6/15/76	REVISED
7/1/76	REVISED
7/15/76	REVISED
8/1/76	REVISED
8/15/76	REVISED

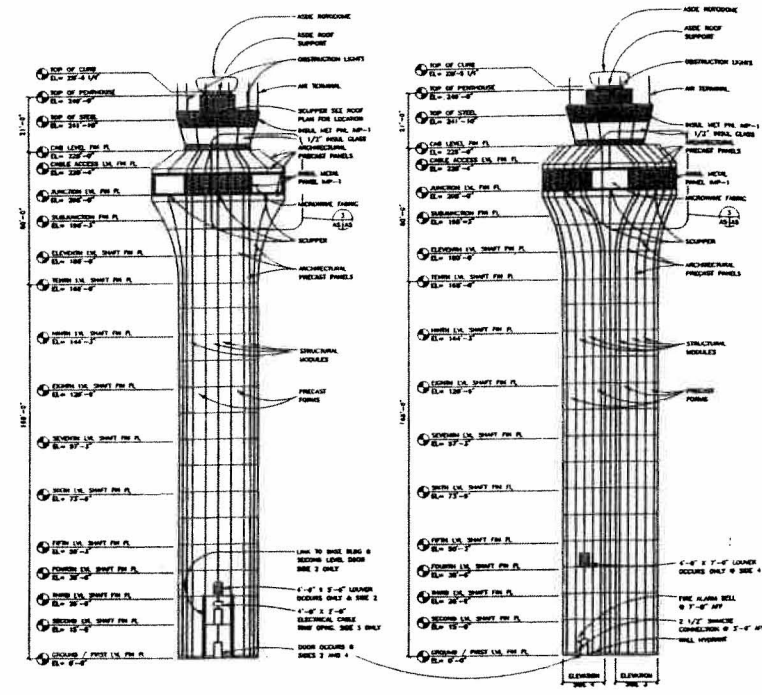

ELEVATION SIDE 2
SCALE 1/8" = 1'-0"

ELEVATION SIDE 1
SCALE 1/8" = 1'-0"

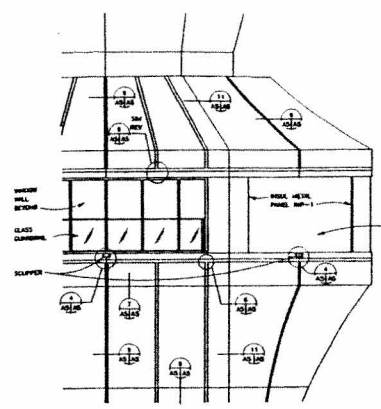

PARTIAL ELEVATION
SCALE 1/4" = 1'-0"

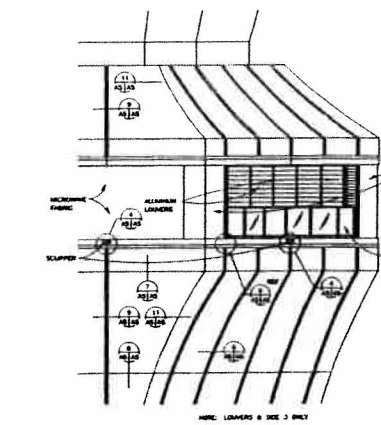

PARTIAL CORNER ELEVATION
SCALE 1/4" = 1'-0"

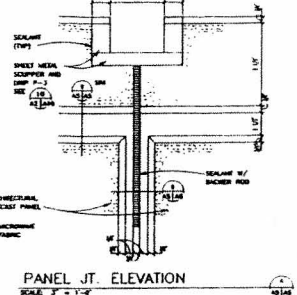

PANEL JT. ELEVATION
SCALE 3" = 1'-0"

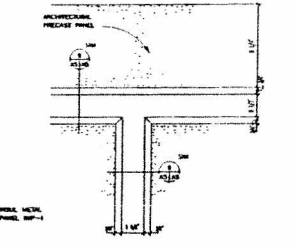

PANEL JT. ELEVATION
SCALE 3" = 1'-0"

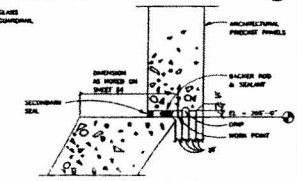

PRECAST JOINT DETAIL
SCALE 3" = 1'-0"

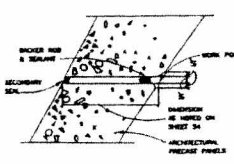

HORIZONTAL JOINT
SCALE 3" = 1'-0"

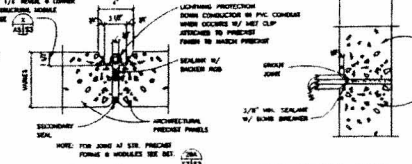

PRECAST JOINT
SCALE 3" = 1'-0"



TYP SHAFT JOINT
SCALE 3" = 1'-0"

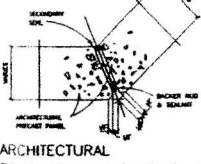

ARCHITECTURAL CORNER JOINT
SCALE 3" = 1'-0"

DEPARTMENT OF TRANSPORTATION FEDERAL AVIATION ADMINISTRATION KANSAS CITY, MISSOURI	
ELEVATIONS KANSAS CITY INTERNATIONAL AIRPORT KANSAS CITY, MISSOURI	
DRAWN BY: [Name] CHECKED BY: [Name] DATE: [Date]	DESIGNED BY: [Name] ENGINEER: [Name] DATE: [Date]
PROJECT: [Project Name] SHEET: [Sheet Number] OF [Total Sheets]	

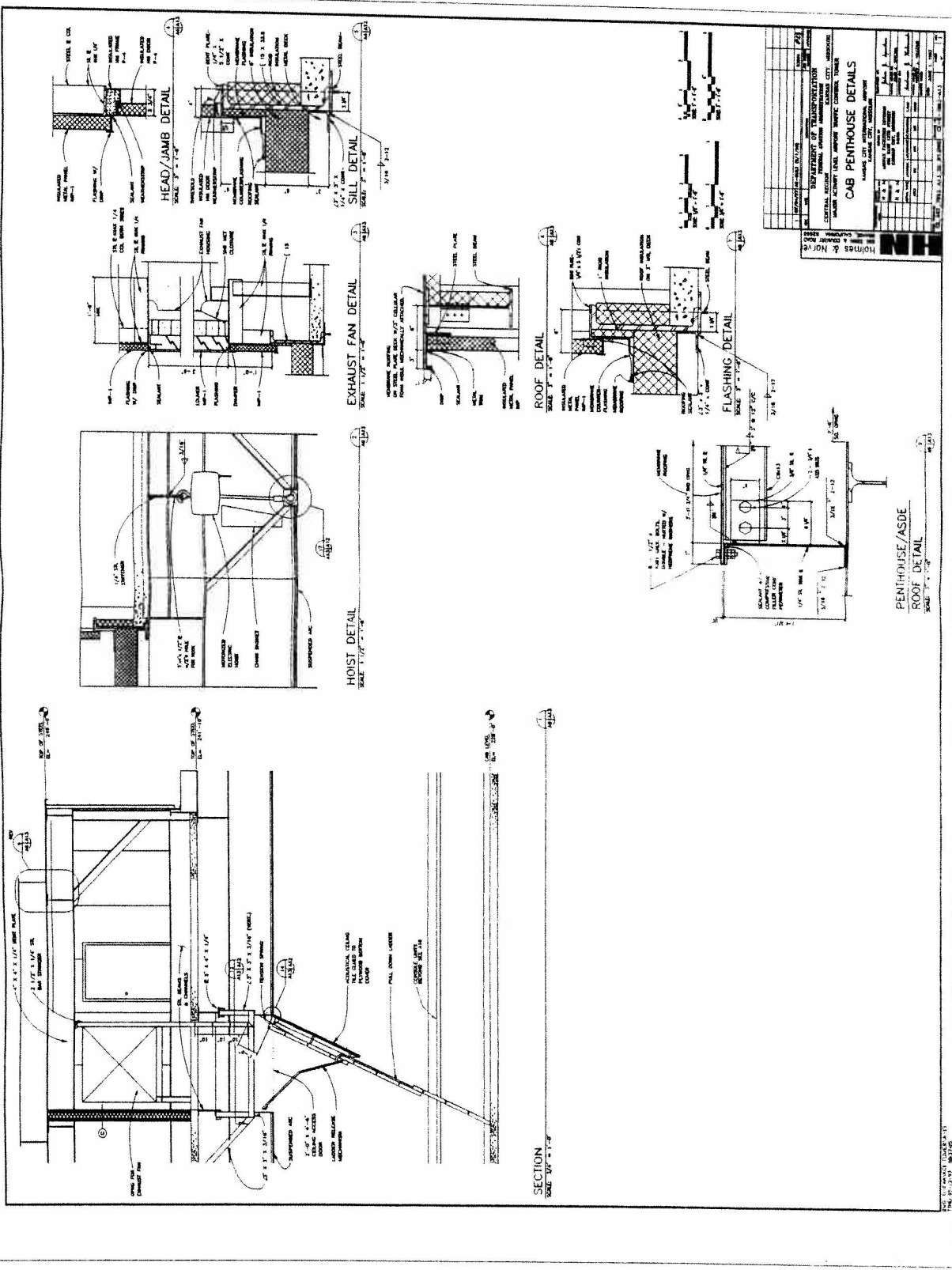

NO. 11 (PENTHOUSE DETAILS) 11
 TNR 07-11-03 08/11/03

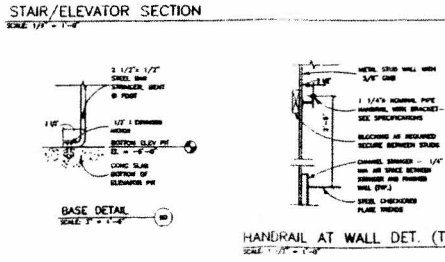
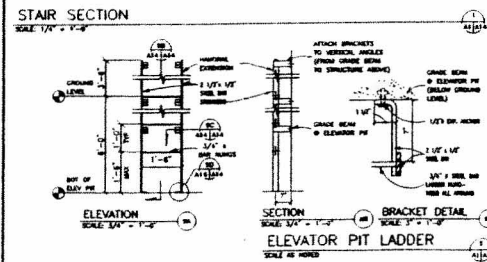
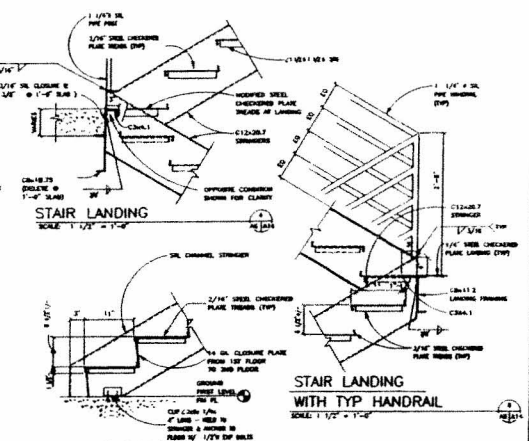
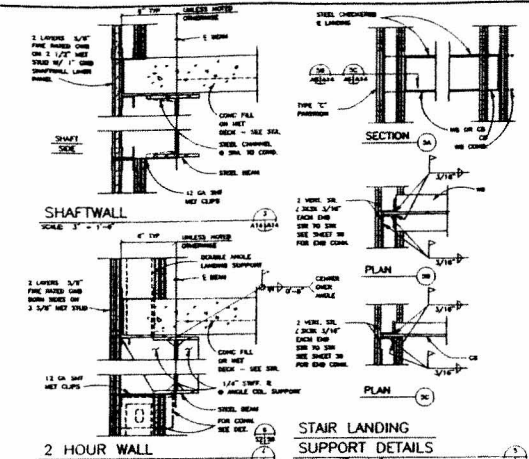
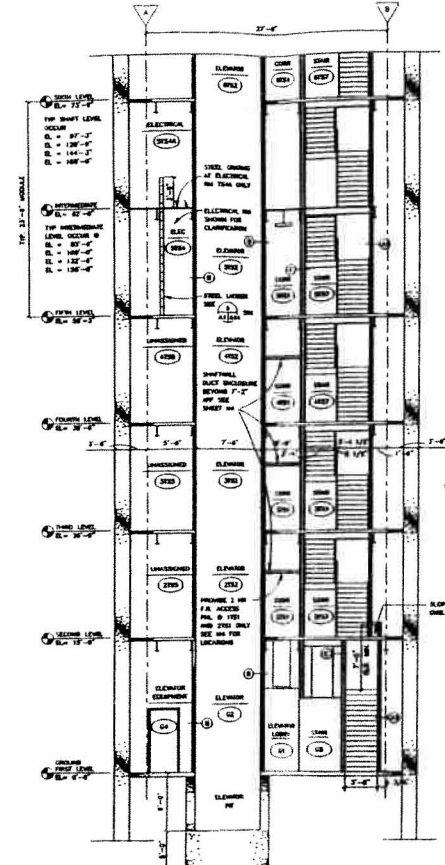
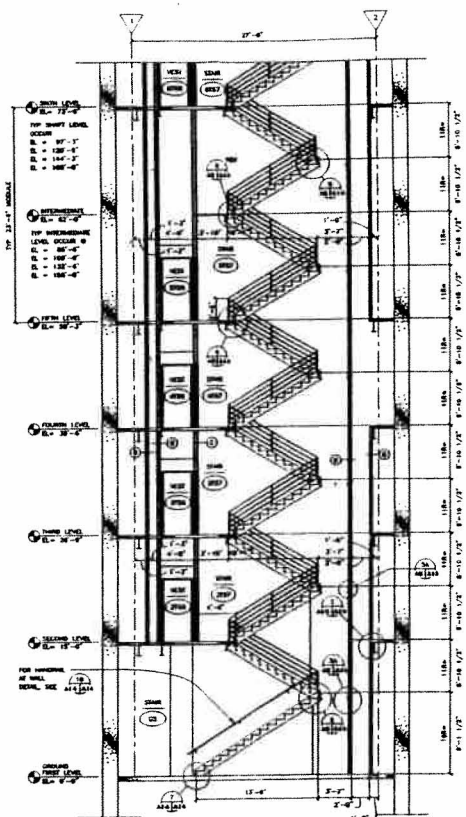

REVISIONS

NO.	DESCRIPTION	DATE
1	ISSUED FOR PERMIT	10/15/23
2	REVISED PER COMMENTS	10/20/23
3	REVISED PER COMMENTS	10/25/23
4	REVISED PER COMMENTS	11/01/23
5	REVISED PER COMMENTS	11/05/23
6	REVISED PER COMMENTS	11/10/23
7	REVISED PER COMMENTS	11/15/23
8	REVISED PER COMMENTS	11/20/23
9	REVISED PER COMMENTS	11/25/23
10	REVISED PER COMMENTS	12/01/23
11	REVISED PER COMMENTS	12/05/23
12	REVISED PER COMMENTS	12/10/23
13	REVISED PER COMMENTS	12/15/23
14	REVISED PER COMMENTS	12/20/23
15	REVISED PER COMMENTS	12/25/23
16	REVISED PER COMMENTS	01/01/24
17	REVISED PER COMMENTS	01/05/24
18	REVISED PER COMMENTS	01/10/24
19	REVISED PER COMMENTS	01/15/24
20	REVISED PER COMMENTS	01/20/24
21	REVISED PER COMMENTS	01/25/24
22	REVISED PER COMMENTS	02/01/24
23	REVISED PER COMMENTS	02/05/24
24	REVISED PER COMMENTS	02/10/24
25	REVISED PER COMMENTS	02/15/24
26	REVISED PER COMMENTS	02/20/24
27	REVISED PER COMMENTS	02/25/24
28	REVISED PER COMMENTS	03/01/24
29	REVISED PER COMMENTS	03/05/24
30	REVISED PER COMMENTS	03/10/24
31	REVISED PER COMMENTS	03/15/24
32	REVISED PER COMMENTS	03/20/24
33	REVISED PER COMMENTS	03/25/24
34	REVISED PER COMMENTS	04/01/24
35	REVISED PER COMMENTS	04/05/24
36	REVISED PER COMMENTS	04/10/24
37	REVISED PER COMMENTS	04/15/24
38	REVISED PER COMMENTS	04/20/24
39	REVISED PER COMMENTS	04/25/24
40	REVISED PER COMMENTS	05/01/24
41	REVISED PER COMMENTS	05/05/24
42	REVISED PER COMMENTS	05/10/24
43	REVISED PER COMMENTS	05/15/24
44	REVISED PER COMMENTS	05/20/24
45	REVISED PER COMMENTS	05/25/24
46	REVISED PER COMMENTS	06/01/24
47	REVISED PER COMMENTS	06/05/24
48	REVISED PER COMMENTS	06/10/24
49	REVISED PER COMMENTS	06/15/24
50	REVISED PER COMMENTS	06/20/24
51	REVISED PER COMMENTS	06/25/24
52	REVISED PER COMMENTS	07/01/24
53	REVISED PER COMMENTS	07/05/24
54	REVISED PER COMMENTS	07/10/24
55	REVISED PER COMMENTS	07/15/24
56	REVISED PER COMMENTS	07/20/24
57	REVISED PER COMMENTS	07/25/24
58	REVISED PER COMMENTS	08/01/24
59	REVISED PER COMMENTS	08/05/24
60	REVISED PER COMMENTS	08/10/24
61	REVISED PER COMMENTS	08/15/24
62	REVISED PER COMMENTS	08/20/24
63	REVISED PER COMMENTS	08/25/24
64	REVISED PER COMMENTS	09/01/24
65	REVISED PER COMMENTS	09/05/24
66	REVISED PER COMMENTS	09/10/24
67	REVISED PER COMMENTS	09/15/24
68	REVISED PER COMMENTS	09/20/24
69	REVISED PER COMMENTS	09/25/24
70	REVISED PER COMMENTS	10/01/24
71	REVISED PER COMMENTS	10/05/24
72	REVISED PER COMMENTS	10/10/24
73	REVISED PER COMMENTS	10/15/24
74	REVISED PER COMMENTS	10/20/24
75	REVISED PER COMMENTS	10/25/24
76	REVISED PER COMMENTS	11/01/24
77	REVISED PER COMMENTS	11/05/24
78	REVISED PER COMMENTS	11/10/24
79	REVISED PER COMMENTS	11/15/24
80	REVISED PER COMMENTS	11/20/24
81	REVISED PER COMMENTS	11/25/24
82	REVISED PER COMMENTS	12/01/24
83	REVISED PER COMMENTS	12/05/24
84	REVISED PER COMMENTS	12/10/24
85	REVISED PER COMMENTS	12/15/24
86	REVISED PER COMMENTS	12/20/24
87	REVISED PER COMMENTS	12/25/24
88	REVISED PER COMMENTS	01/01/25
89	REVISED PER COMMENTS	01/05/25
90	REVISED PER COMMENTS	01/10/25
91	REVISED PER COMMENTS	01/15/25
92	REVISED PER COMMENTS	01/20/25
93	REVISED PER COMMENTS	01/25/25
94	REVISED PER COMMENTS	02/01/25
95	REVISED PER COMMENTS	02/05/25
96	REVISED PER COMMENTS	02/10/25
97	REVISED PER COMMENTS	02/15/25
98	REVISED PER COMMENTS	02/20/25
99	REVISED PER COMMENTS	02/25/25
100	REVISED PER COMMENTS	03/01/25

STAIR AND ELEVATOR TOWER
 HANSAH CITY INTERNATIONAL AIRPORT
 LANSING CITY, MICHIGAN

DESIGNED BY: [Name]
 CHECKED BY: [Name]
 IN CHARGE: [Name]

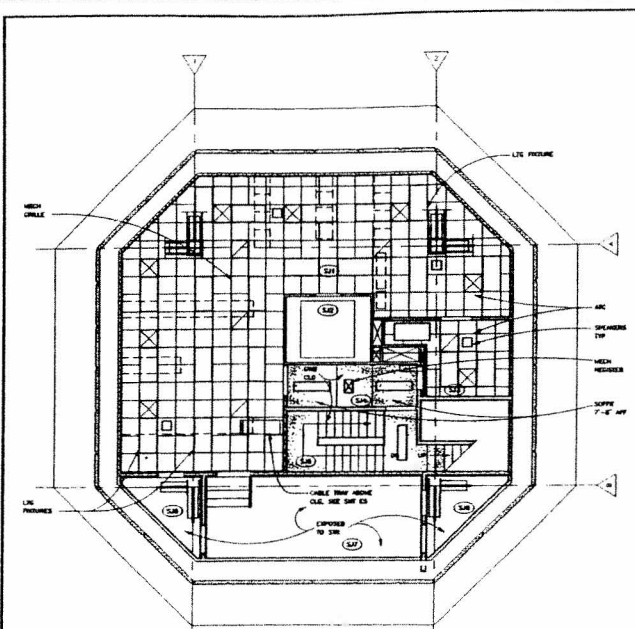

SUBJUNCTION LEVEL REFLECTED CEILING PLAN
SCALE 1/8" = 1'-0"

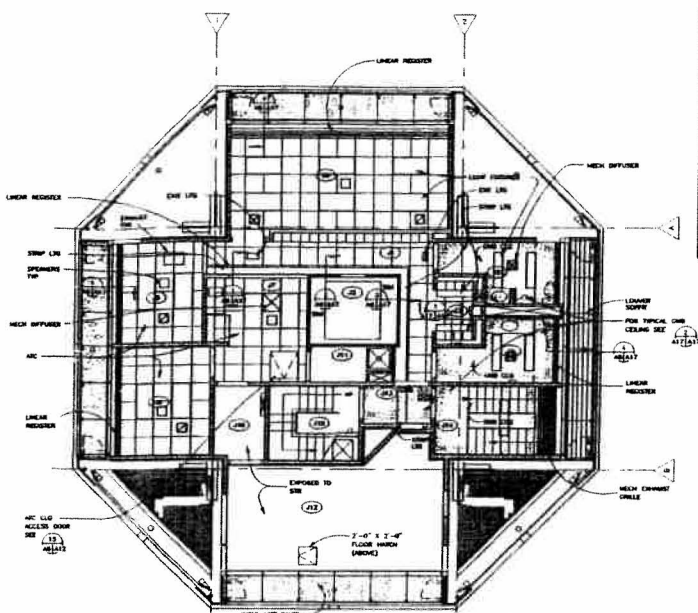

JUNCTION LEVEL REFLECTED CEILING PLAN
SCALE 1/8" = 1'-0"

ROOM SCHEDULE	
NO.	NAME
S21	ELECTRONIC EQUIPMENT
S22	CLERK
S23	SHOP
S24	VESTIBULE
S25	STAIR
S26	AIR SHED
S27	MECHANICAL ROOM
S28	AIR SHED
Z1	STAIR
Z2	STAIR
Z3	STAIR
Z4	STAIR
Z5	STAIR
Z6	STAIR
Z7	STAIR
Z8	STAIR
Z9	STAIR
Z10	STAIR
Z11	STAIR
Z12	STAIR
Z13	STAIR
Z14	STAIR
Z15	STAIR
Z16	STAIR

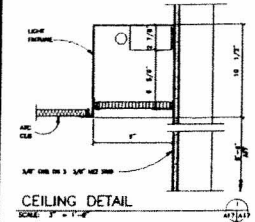

CEILING DETAIL
SCALE 3/4" = 1'-0"

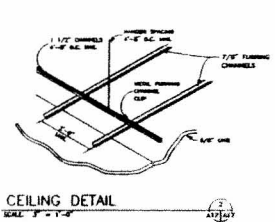

CEILING DETAIL
SCALE 3/4" = 1'-0"

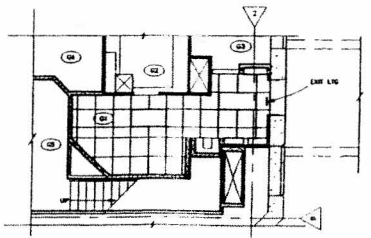

PARTIAL GROUND LEVEL REFLECTED CEILING PLAN
SCALE 1/8" = 1'-0"

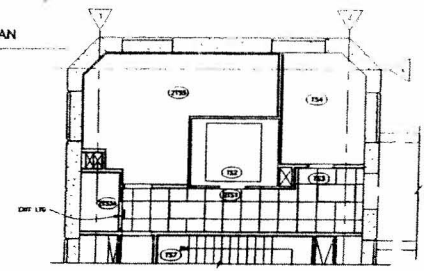

PARTIAL SECOND LEVEL REFLECTED CEILING PLAN
SCALE 1/8" = 1'-0"

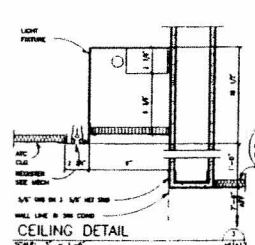

CEILING DETAIL
SCALE 3/4" = 1'-0"

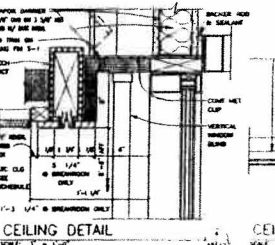

CEILING DETAIL
SCALE 3/4" = 1'-0"

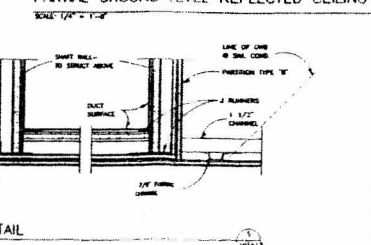

CEILING DETAIL
SCALE 3/4" = 1'-0"

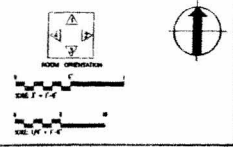

DEPARTMENT OF TRANSPORTATION	
CENTRAL RECORD	
PROJECT NO.	100-117-100-01
DATE	12-2-1953
BY	J. J. ...
CHECKED BY	J. J. ...
APPROVED BY	J. J. ...
TITLE	REFLECTED CEILING PLANS AND DETAILS
SCALE	AS SHOWN
DATE	12-2-1953
BY	J. J. ...
CHECKED BY	J. J. ...
APPROVED BY	J. J. ...

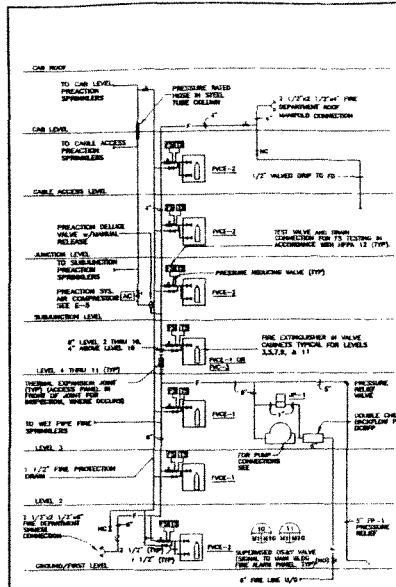

STANDPIPE RISER DIAGRAM
NO SCALE

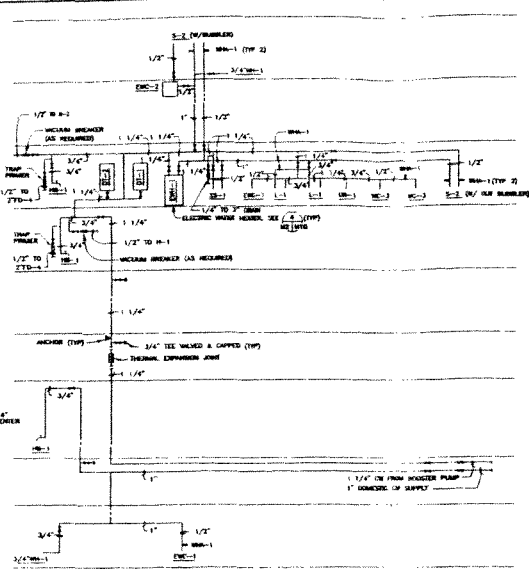

DOMESTIC WATER RISER DIAGRAM
NO SCALE

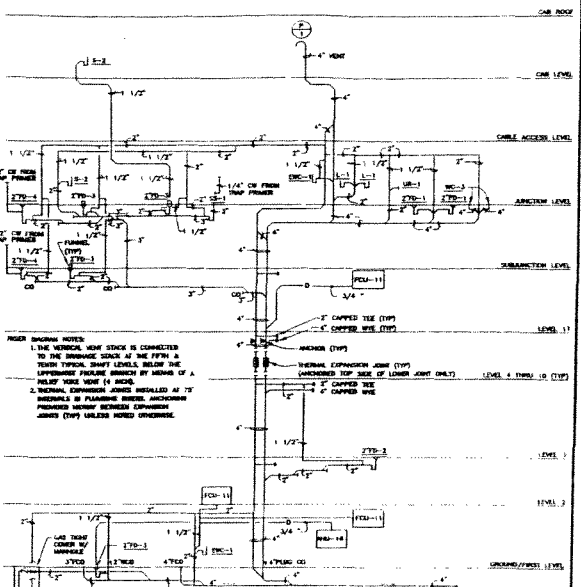

WASTE AND VENT RISER DIAGRAM
NO SCALE

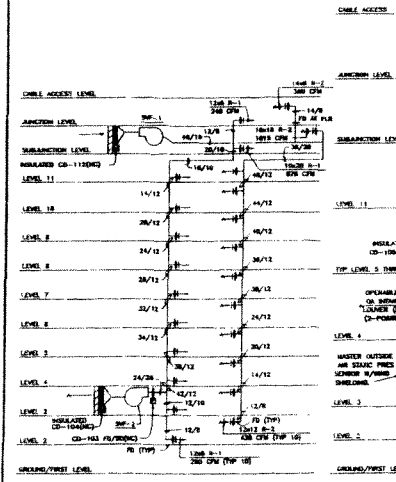

VESTIBULE SMOKE CONTROL RISER
NO SCALE

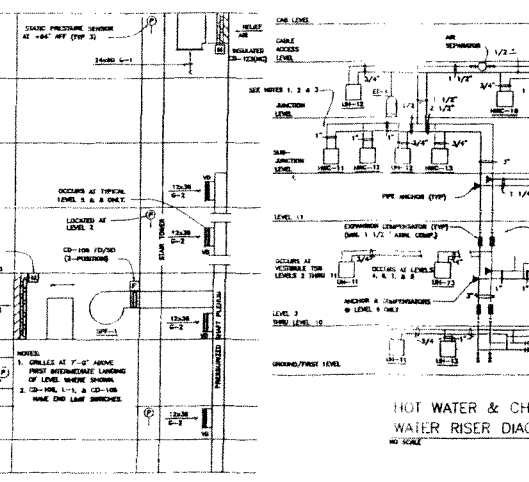

STAIRWELL PRESSURIZATION RISER DIAGRAM
NO SCALE

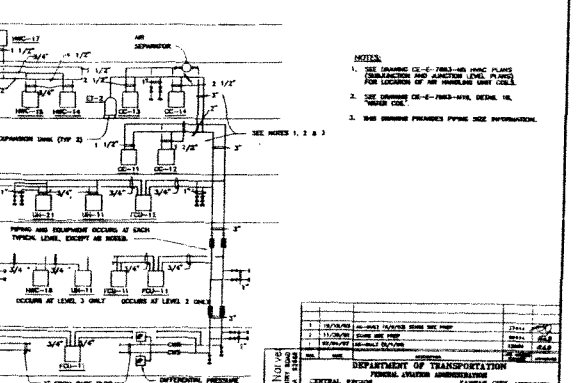

HOT WATER & CHILLED WATER RISER DIAGRAMS
NO SCALE

- NOTES:
- SEE DRAWING CE-2-7883-08 FOR PLUMBING CONNECTIONS AND ANCHORING LEVELS FOR LOCATION OF AIR TREATMENT UNIT LEVEL.
 - SEE DRAWING CE-2-7883-09, DETAIL 16, TYPICAL CONNECTION.
 - SEE DRAWING FRAMED PIPE SIZE INFORMATION.

RISER DIAGRAMS			
HARRIS CITY INTERNATIONAL AIRPORT			
HARRIS CITY, MISSOURI			
NO. 1	STANDPIPE RISER	DATE	10/1/78
NO. 2	DOMESTIC WATER RISER	DATE	10/1/78
NO. 3	WASTE AND VENT RISER	DATE	10/1/78
NO. 4	VESTIBULE SMOKE CONTROL RISER	DATE	10/1/78
NO. 5	STAIRWELL PRESSURIZATION RISER	DATE	10/1/78
NO. 6	HOT WATER & CHILLED WATER RISER	DATE	10/1/78

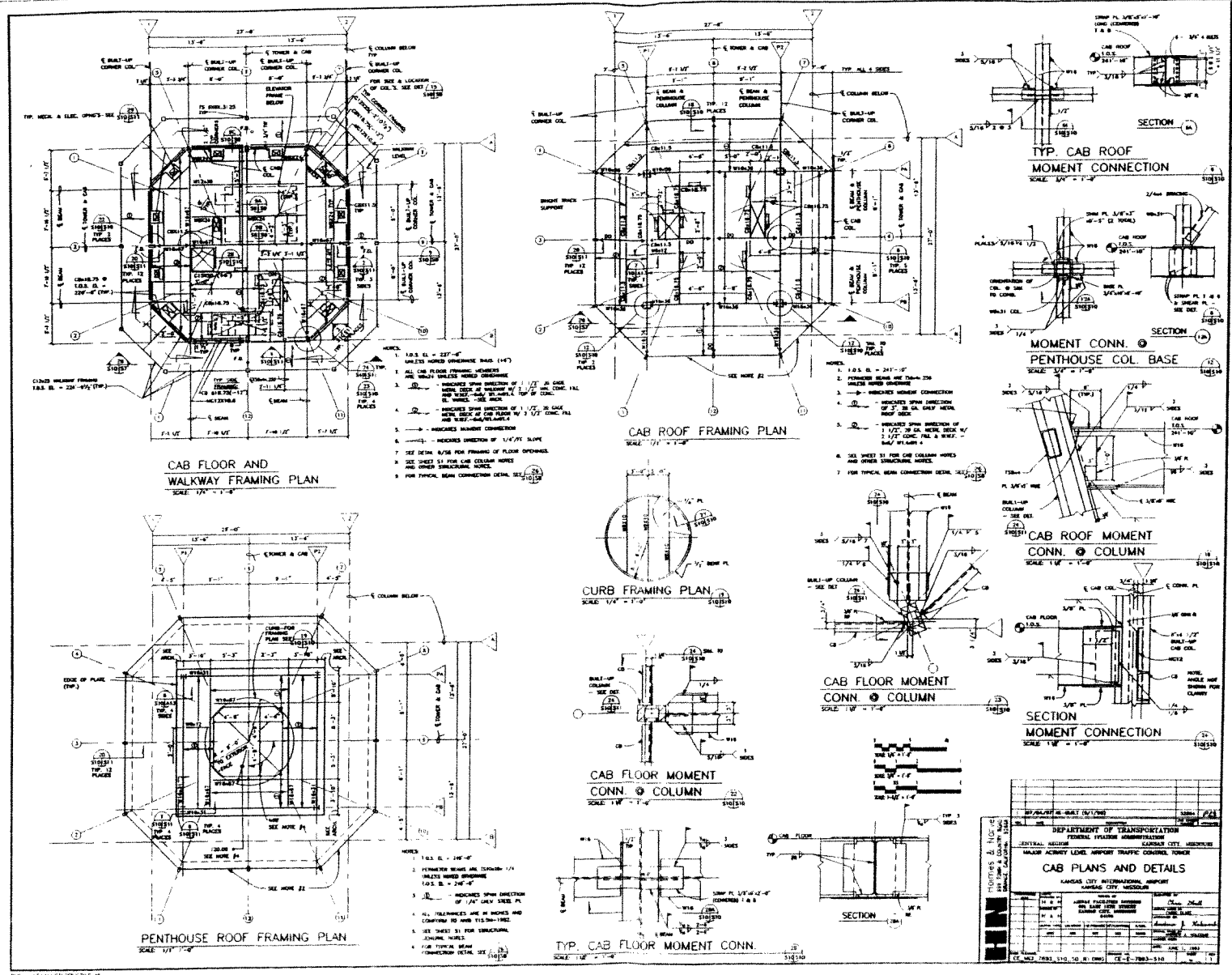

DEPARTMENT OF TRANSPORTATION TOWNSHIP ENGINEERING			
KANSAS CITY METROPOLITAN AREA MAJOR ARCADE LEVEL, IMPROVED TRAFFIC CONTROL, TOWER			
KANSAS CITY INTERNATIONAL AIRPORT KANSAS CITY, MISSOURI			
PROJECT NO.	DATE	BY	CHECKED
100-100-100	10/1/50	J. H. HARRIS	J. H. HARRIS
DESIGNED BY	DATE	BY	CHECKED
J. H. HARRIS	10/1/50	J. H. HARRIS	J. H. HARRIS
SCALE	DATE	BY	CHECKED
AS SHOWN	10/1/50	J. H. HARRIS	J. H. HARRIS
APPROVED	DATE	BY	CHECKED
J. H. HARRIS	10/1/50	J. H. HARRIS	J. H. HARRIS